



Brochure & Technical Data





The Middle East's First Modular Swimming Pool





The Pinnacle of Modular Pool Luxury



Imagine a swimming pool that fits seamlessly into your lifestyle and landscape. The ThermaPool, our luxury modular swimming pool, offers just that. Customisable with modular loungers that display ultra-luxury LED lighting, the ThermaPool brings the bliss of indulging in water to your garden. The innovative modular design ensures quick installation and the flexibility to adapt to any space; whether it be a small garden patio or a terrace, the high-quality materials and elegant aesthetics promise years of enjoyment and style.



Introducing ThermaPool: A New Era of Luxury Modular Swimming Pools in the UAE

Elevate your home with the unparalleled elegance and innovation of the ThermaPool, the first of its kind in the UAE, brought to you by The Water Works. This luxurious modular swimming pool is not just a pool; it's a statement of sophisticated living, designed to provide an unmatched aquatic experience.

Exquisite Design and Unmatched Durability

Crafted from premium GRP composite with a 10mm GRP Reinforced Shell, the ThermaPool sets the standard for durability and style. Finished with an antibacterial, hypoallergenic epoxy gel coat, it offers a lustrous, high-quality finish that not only looks spectacular but is also built to last against the harsh UAE climate.

Luxury Meets Innovation with Modular Design

Transform your backyard or terrace into a stunning oasis with ThermaPool's customisable modular design. Featuring integrated loungers with atmospheric LED lighting, the pool invites you to immerse in an ambient relaxation space that is both beautiful and functional. Each lounge is adorned with high-quality waterproof fabric cushions as standard, enhancing comfort while adding a touch of elegance.

Smart Temperature Control for Year-Round Enjoyment

Equipped with a powerful heater chiller unit that is Wi-Fi/app compatible, the ThermaPool allows you to control the water temperature to suit your preference, ensuring perfect swimming conditions throughout the year. Whether it's cooling down during the hot summer months or heating up for a comfortable winter dip, your pool's temperature is always at your fingertips.

Sustainable Luxury at Its Best

The ThermaPool is not only a luxury statement but also a nod to sustainability. Built with a 3-side overflow system, it ensures efficient water use and superior cleanliness, reflecting our commitment to eco-friendly design. Not only that, there is no construction required on site and the product can be moved anywhere at anytime.



Three Unique Colours

Artic White

Grecian Beige

Amalfi Grey

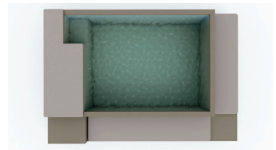
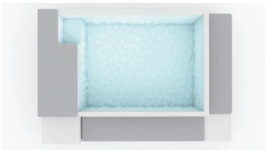
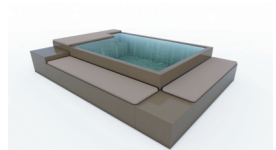
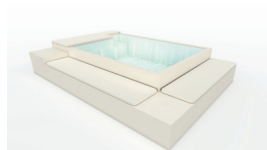
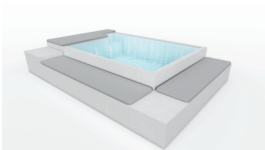
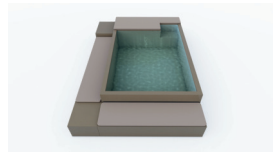
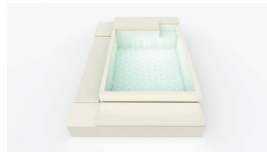
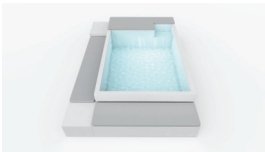
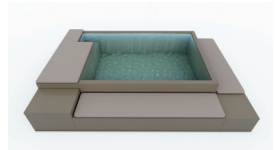
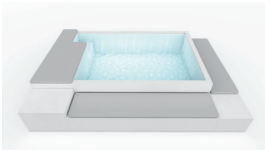



Technical Data



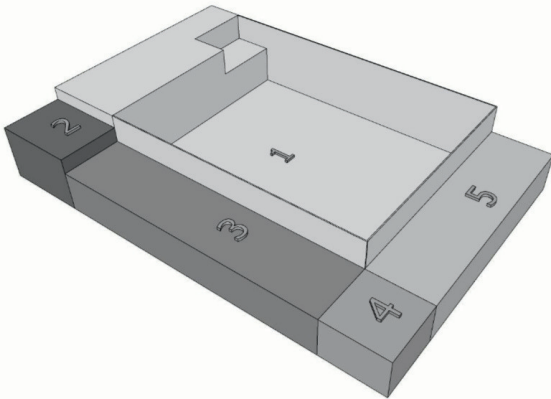
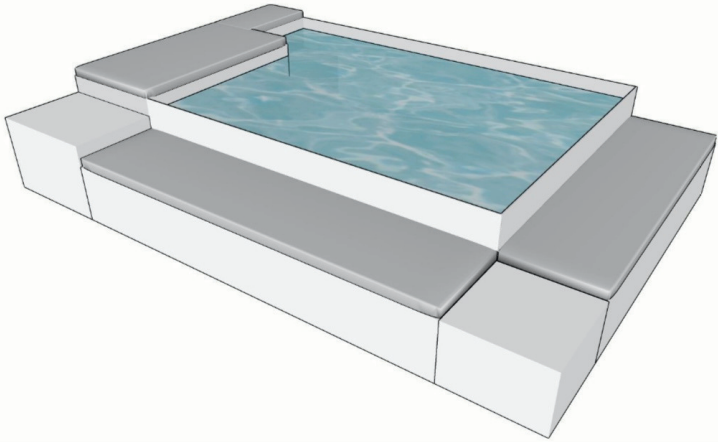

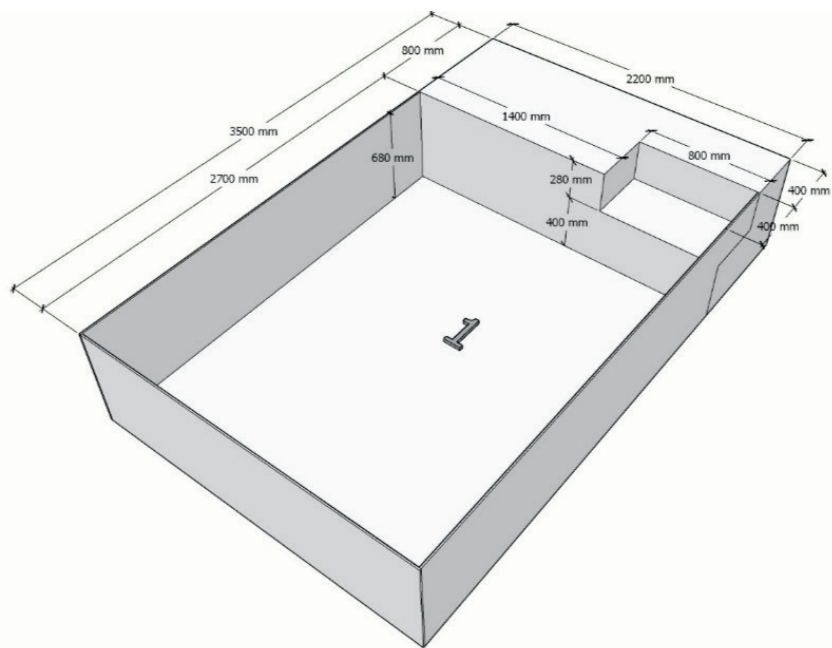

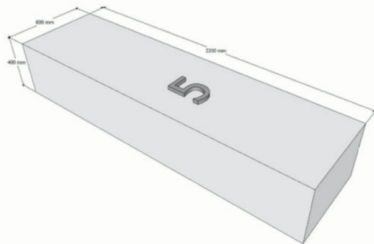
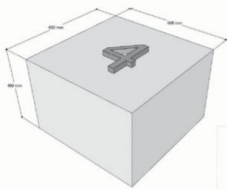
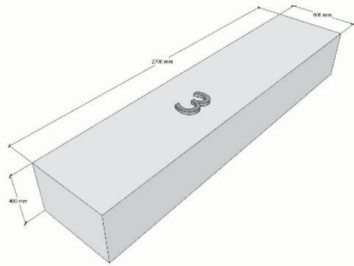
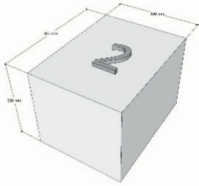

1HP Self Priming Pump



TECHNICAL CHARACTERISTICS
 RENSEIGNEMENTS TECHNIQUES
 CARACTERÍSTICAS TÉCNICAS
 DATI TECNICI
 TECHNISCHE ANGABEN
 CARACTERÍSTICAS TÉCNICAS

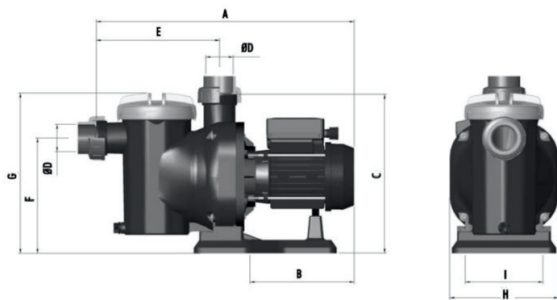

COD.	Cv	A	B	C	D	E	F	G	H	I
25461	1/3 II	472,5	191,1	290,5	50	225,5	210,5	292	199	142
25462	1/2 II	472,5	191,1	290,5	50	225,5	210,5	292	199	142
25463	3/4 II	489	208,2	290,5	50	225,5	210,5	292	199	142
25464	3/4 III	489	208,2	290,5	50	225,5	210,5	292	199	142
25465	1 II	489	208,2	290,5	50	225,5	210,5	292	199	142
25466	1 III	489	208,2	290,5	50	225,5	210,5	292	199	142
25467	1,25 II	489	208,2	290,5	50	225,5	210,5	292	199	142
25468	1,25 III	489	208,2	290,5	50	225,5	210,5	292	199	142

See performance curves on next page.

SELF-PRIMING PUMPS

Sena pump



A compact self-priming pump with single-phase from 1/3 hp up to 1.25 hp in and three-phase motors from ¼ hp to 1.25 hp. GS marking. IP-55 protection rating. Class F insulation and AISI-316 stainless steel for all components in direct contact with water. Glue-in pipe connection sleeve 50 mm in diameter.

Flow rates in l/h at 6 mwc for 0.33 hp, 8 mwc for 1/2 hp and 10 mwc for the rest of range, 3,000 rpm.

	Code	Standard Pack	Standard Weight in kg	Standard Volume in m ³
7,000 l/h, 1/3 HP, 230 V II	25461	1	10.20	0.055
7,800 l/h, ½ HP, 230 V II	25462	1	10.20	0.055
9,000 l/h, ¾ HP, 230 V II	25463	1	11.65	0.055
9,000 l/h, ¾ HP, 230/400 V III	25464	1	11.40	0.055
11,800 l/h, 1 HP, 230 V II	25465	1	12.75	0.055
11,800 l/h, 1 HP, 230/400 V III	25466	1	13.00	0.055
14,000 l/h, 1.25 HP, 230 V II	25467	1	13.75	0.055
14,000 l/h, 1.25 HP, 230/400 V III	25468	1	13.55	0.055

PERFORMANCE CURVES PRESSURE - FLOW / COURBES DE RENDEMENT / CURVAS DE RENDIMIENTO / LEIGSTUNKURVE / CURVA DI RENDIMENTO / CURVA DI RENDIMIENTO

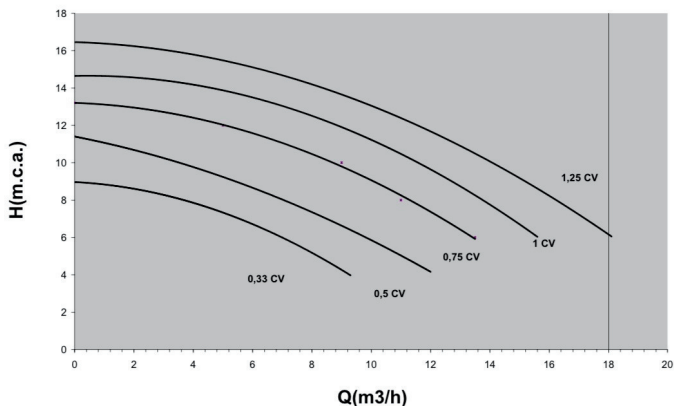



Heater Chiller Unit

POOL HEATING Heat & Chill Pump

HEAT AND CHILL PUMP

PROTEAM Europa Heat and Chill pump can be used for heating or cooling swimming pool, spa or some other open water system. The heat and chill pump manufactured very highest international standard quality with advanced technologies to maximize the performance and minimize the consumption. In consideration of this, PROTEAM heat pumps have always been specifically designed to have higher COP at lower temperature when maximum energy is needed. All PROTEAM heat pumps will be available with environmentally friendly refrigerant.

HOW DO HEAT PUMP WORKS

PROTEAM Europa Heat pump and chill pump principle Heat pumps function like a reversed air conditioning cooling system. The heat pump fan draws ambient air through the outer evaporator air coil that acts as a heat collector. The air coil has a liquid refrigerant which absorbs available heat in the passing air transforming it into a gas which is compressed by a compressor. When the gas is compressed it intensifies and concentrates the heat. This intense hot gas is then pumped into the heat exchange condenser where the actual heat exchanger takes place. As the pool water passes through the heat exchanger, the hot gas gives up its heat to the cooler pool water. Uses freely available air energy 4-5 times more effectively than conventional electrical heaters. If heat energy is converted to KW you get 4-5 kW of heating/cooling output for every KW of power consumed, you get at least 4-5KW of free power.

HIGHLY EFFICIENCY

Adopt heat pump for heating and the energy comes from ambient air. So its COP can reach 4.0 - 5.0. 70% can be saved compared with normal electrical heater.

SAFETY

Water and electricity are completely separate. ECO friendly gas, no fire, no electricity leakage, safer than fuel burner or electrical heater.

ENVIRONMENTALLY FRIENDLY

Adopt R407-C, R410-A, R134-A, R22 as refrigerant according to the requirements of EU Montreal protocol.

LONG LIFE RUNNING

Titanium heat exchanger in PVC shell makes it super strong and resistant against erosion caused by chlorine and salt. SS316 casing for titanium heat exchanger is an option.

COMPRESSOR

We use the reliable COPELAND scroll compressor. The simple design is with very few moving parts that enable it to operate at lower sound and vibration levels than reciprocating compressors. Test has shown that scroll compressors are up to three times quieter than other models. Millions of air conditioner around the world using Copeland scroll compressors is testimony to its quality and efficiency.

WATER HEAT EXCHANGER

This is made of double spiraled titanium tubes encased in PVC for additional protection against corrosive pool water. Titanium heat exchangers are superior to stainless steel and make the heat pump more efficiency and cost effective. The double spiraling of the heat exchanger increases the surface area that comes in contact with the pool water and also drastically reduces scaling.

EXTERNAL HEAT EXCHANGER

The tubes are made of copper and the fins in aluminium. The extra-large evaporator coils are designed to collect more heat from the outside air to ensure performance in even the most adverse conditions.

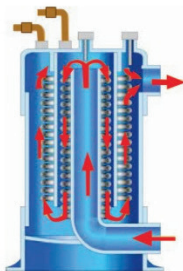



Model 00500188

POOL HEATING Heat & Chill Pump



TECHNICAL SPECIFICATION

Specification		Model				
		00500188	00500133	00500130	00500117	00500170
Heating Capacity	Kw	8.8	13	13	17	17
	BTU/hr	30000	44000	44000	58000	58000
Heating Power Input	kw	1.9	2.65	2.65	3.7	3.7
Cooling Capacity	kw	5.8	8.8	8.8	12	12
	BTU/hr	19720	30000	30000	41000	41000
Cooling Power Input	kw	2.1	2.85	2.85	3.9	3.9
Running Current	A	8.6/9.6	13.6/14.3	13.6/14.3	18.0/19.1	18.0/19.1
COP		4.9	4.9	4.9	4.8	4.8
Power Supply	V/PH/Hz	230/1/50	230/1/50	230/1/50	230/1/50	230/1/50
Compressor		1	1	1	1	1
Compressor Model		Rotary	Rotary	Rotary	Scroll	Scroll
Fan Quantity		1	1	1	1	1
Fan Input Power	W	150	150	200	150	200
Fan Rotate Speed	RPM	850	850	830	850	830
Fan Direction		Horizontal	Horizontal	Horizontal	Horizontal	Vertical
Noise	dB(A)	56	58	58	58	58
Water Connection	mm	50	50	50	50	50
Water Flow Volume	m ³ /hr	3	6	6	7.5	7.5
Water Pressure Drop (Max)	kPa	8	8	8	10	10
Unit Net Dimension (L/W/H)	mm	1010*420*650	1120*470*850	660*660*860	1120*700*920	660*660*860
Unit Net Weight	kg	77	90	86	100	100



Pool Lighting - Warm/Cool White 1 x 10w Stainless Steel Ultra Slim LED Light

LIGHTING Ultra Mini Slim LED Lights



ULTRA MINI SLIM LED LIGHTS

Proteam Europa ultra slim 8 mm thickness swimming pool and spa LED lights. LED lamps made of SMD Resin with high light output. The light is very easy to assemble and comes with a white high chlorine resistant plastic ring. These can be mounted in two ways and directly against the wall without cable space. Color temperature 2700K- 6500K, Beam angle 120°, IP 68, Cable length 3m.

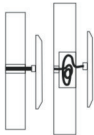
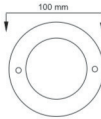
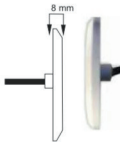

Code	Power	Color	Diameter	Lumens	Voltage	LED
00852232	5W	RGB	100mm	400m	12V DC	SMD2835
00852233	5W	Cool white	100mm	450m	12VDC	SMD2835
00852234	5W	Warm white	100mm	450m	12VDC	SMD2835
00852235	5W	Blue	100mm	400m	12VDC	SMD2835
00852236	8W	RGB	100mm	640m	12VDC	SMD2835
00852237	8W	Cool white	100mm	680m	12VDC	SMD2835
00852238	8W	Warm white	100mm	700m	12VDC	SMD2835
00852239	8W	Blue	100mm	640m	12VDC	SMD2835
00852240	10W	RGB	100mm	800m	12VDC	SMD2835
00852241	10W	Cool white	100mm	890m	12VDC	SMD2835
00852242	10W	Warm white	100mm	920m	12VDC	SMD2835
00852243	10W	Blue	100mm	800m	12VDC	SMD2835

Ultra slim LED Lights ABS Plastic

00852244	5W	RGB	100mm	400m	12VDC	SMD2835
00852245	5W	Cool white	100mm	450m	12VDC	SMD2835
00852246	5W	Warm white	100mm	450m	12VDC	SMD2835
00852247	5W	Blue	100mm	400m	12VDC	SMD2835
00852248	8W	RGB	100mm	640m	12V DC	SMD2835
00852249	8W	Cool white	100mm	680m	12VDC	SMD2835
00852250	8W	Warm white	100mm	700m	12VDC	SMD2835
00852251	8W	Blue	100mm	640m	12VDC	SMD2835
00852252	10W	RGB	100mm	800m	12VDC	SMD2835
00852253	10W	Cool white	100mm	890m	12VDC	SMD2835
00852254	10W	Warm white	100mm	920m	12VDC	SMD2835
00852255	10W	Blue	100mm	800m	12VDC	SMD2835



Modular Lounger Lighting

LED Strip Lighting - Warm/Cool White

LIGHTING Strip Lighting



FLEXIBLE LED STRIP LIGHTS (30/60 LED PER METER)

Maintenance free, with 3M adhesive tape on the back for easy installation. Solid-state, high shock or vibration resistant. Continuous length flexible LED light strips. Waterproof or non-waterproof are available. Low power consumption, high intensity. Major reduction in power costs. Long life up to 50,000 hours. Standard CE certification and ROHS compliance LED QTY 30/60 psc 5050 SMD LED per meter. IP Rate IP20/IP65/IP67/IP68. Strip size 5m length

Code	LED Chips	LED Qty (m)	Colour	Input Voltage	Wattage (m)
30PCS LED PER METER					
00852310	5050 SMD	30	Red	12/24 VDC	7.2
00852311	5050 SMD	30	Green	12/24 VDC	7.2
00852312	5050 SMD	30	Blue	12/24 VDC	7.2
00852313	5050 SMD	30	Yellow	12/24 VDC	7.2
00852314	5050 SMD	30	Cool White	12/24 VDC	7.2
00852315	5050 SMD	30	Warm White	12/24 VDC	7.2
00852316	5050 SMD	30	RGB	12/24 VDC	7.2
60PCS LED PER METER					
00852317	5050 SMD	60	Red	12/24 VDC	14.4
00852318	5050 SMD	60	Green	12/24 VDC	14.4
00852319	5050 SMD	60	Blue	12/24 VDC	14.4
00852320	5050 SMD	60	Yellow	12/24 VDC	14.4
00852321	5050 SMD	60	Cool White	12/24 VDC	14.4
00852322	5050 SMD	60	Warm White	12/24 VDC	14.4
00852323	5050 SMD	60	RGB	12/24 VDC	14.4
Aluminium Profile					
00852324		1 mtr Length			IP Rating 20

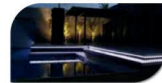



Stainless Steel Inlet Fittings



- Ø20 mm: 4.5 m³/h *According with EN standards if installed at a maximum of 500mm below pool water level
- Ø25 mm: 7 m³/h
- 4 x Ø7.8 mm: 2.9 m³/h

	Code	Standard Pack	Standard weight in kg	Standard volume in m ³
Round - Ball 20mm - L35mm	75164	1	0.325	0.001
Round - Ball 20mm - L50mm	75165	1	0.415	0.001
Round - Ball 25mm - L35mm	75166	1	0.295	0.001
Round - Ball 25mm - L50mm	75167	1	0.385	0.001
Round Ball 4 x 7.8mm - L35mm	75168	1	0.305	0.001
Round Ball 4 x 7.8mm - L50mm	75169	1	0.395	0.001
Square - Ball 20mm - L35mm	75170	1	0.325	0.001
Square - Ball 20mm - L50mm	75171	1	0.415	0.001
Square - Ball 25mm - L35mm	75172	1	0.295	0.001
Square - Ball 25mm - L50mm	75173	1	0.385	0.001
Square - Ball 4 x 7.8mm - L35mm	75174	1	0.305	0.001
Square - Ball 4 x 7.8mm - L50mm	75175	1	0.395	0.001



Cantilever Parasol





The Glatz Fortano umbrella is a strong and stable Cantilever umbrella designed with Restaurants and Hotels in Mind. With easy opening and closing, 360 rotation and the ability to withstand high Windspeeds.

Frame: 8-part made from aluminium with crank mechanism. Patent pending opening mechanism for particularly high closing heights. The pole profile is oval 66 × 95 × 3mm. With hand crank.

Strong Cantilever Umbrella
2 year Manufacturers Warranty
360 rotation
Anthracite Grey Frame (RAL 7016)
Max Windspeed 55 Km/H
M4 180 Kg Base with Concrete tiles
Size 400x300cm



Additional Equipment

Maintenance Kit	To Include 2.5m Telescopic Handle, 10-15m 1½" flexible hose, 15" Curve Brush, Deep Net or Leaf Net and 9" vacuum Head
Cartridge Filter	Proteam Cartridge Filter Element CF750
Pipes	E-Class wall thickness not less than 2.5mm- (Size Range ½" to 2½") withstanding pressure of not less than 9 Bar
Fittings/Valves	Size Range ½" to 2½") withstanding pressure of not less than 9 Bar
Transformer	Transformer 240Volts to 12Volts x 300Watt Step Down Magnetic transformer
Control Panel	Wall Mounted Powder coated metal box with required ELCB MCCB, Isolators, analogue Clock Timer & Remote switches as per DEWA & municipality Specifications. (Class 1-IP55)
Pool Cover	Full Pool Cover with high quality waterproof fabric

